

KR-03A "PUCHATEK" GLIDER

FLIGHT MANUAL

Model: KR-03a
Serial No: 03-14
Registration: N3097M
Document No: IU-AB-00.02
Date of Issue: November 1990
Pages identified by "Appr." Are approved

Signature:

Authority: GENERAL INSPECTORATE OF CIVIL
AVIATION-CIVIL AIRCRAFT INSPECTION BOARD /GILC-
IKCSP/

Stamp:

Original date of approval:
1990-11-28

This sailplane is to be operated in compliance with the
information and limitations contained herein.

Intentionally left blank

0.1 Record of revisions.

Any revision of the present manual, except actual weighing data, must be recorded in the following table and the in case of approved Sections endorsed by the responsible airworthiness authority.

The new or amended text in the revised page will indicated by a black vertical line in the left margin, and the Revision No. and the date will be shown on the bottom left hand of the page

KR-03A Flight Manual

Rev. No.	Affected Sections	Affected Pages	Date	Appr.	Date	Date Inserted	Signature
1	7.8	7.6	1990-03-05				
			BE-10/KR-		1992-03-02	1991-03-08	
	0.2	.04	03A/91				
	0.2	.04 (c)					
	1.2	1.2 (c)					
	2.7	2.6					
	2.10	2.8					
2	2.11	2.8, 2.9					
	2.12	2.10, 2.11, 2.12					
		2.13	1991-07-15		1992-03-02	1991-07-17	
	4.4.3	4.5	B2-12/KR-				
	4.5.2	4.9	03A/91				
	4.5.3	4.9					
	5.2.2	5.3					
		0.2	.04, .04 (c)				
		2.5	2.6				
		2.9	2.7				
		2.11	2.9				
	2.12	2.11					
3	3.8	3.5					
	5.2.2	5.4					
	5.3.1	5.4					
	6.2	6.3			1991-11-15	1991-11-15	
	6.5	6.4	1991-11-72				
	6.6	6.10	B2-				
	6.7	6.11	18/KR03A/91				
	7.2	7.3					
	7.9	7.7					
		0.2	.04, 0.5, 0.6				
4	2.11	2.8					
	3.4	2.10					
	3.5	3.3					
	3.6	3.4					
	4.5.3	3.5			1991-11-15	1991-11-15	
	4.5.8	4.9					
	7.9	4.12	1991-11-12				
		7.7	B2-19/KR-				

KR-03A
Flight Manual

			03A/91				
	1.2	1.2					
	1.4	1.3					
	2.3	2.4			1992-03-02	1992-03-02	
5	2.5	2.6					
	2.12(e)	2.10					
	2.12(e)	2.11	1991-11-12 B2-19/KR- o3A/91				

KR-03A
Flight Manual

0.2 List of Effective Pages.

Section	Page	Date
0	0.1	
	0.2	
	0.3	
	0.4	Nov. '90
	0.5	
	0.5	
	0.6	
1	0.7	
	1.1	
	1.2	
	1.3	
	1.4	Nov. '90
	1.5	
	1.6	
2	1.7	
	1.2 /c/	June, '91
	2.1	
	Appr. 2.2	
	Appr. 2.3	
	Appr. 2.4	
	Appr. 2.5	
	Appr. 2.6	Nov. '90
	Appr. 2.7	
	Appr. 2.8	
	Appr. 2.9	
	Appr. 2.10	
	Appr. 2.11	
Appr. 2.12		
Appr. 2.13	June, '91	
Appr. 2.8/AUS,NZ	Nov, '91	
Appr. 2.9/ AUS,NZ	Nov. '91	
Appr. 2.10/AUS,NZ	Nov. '91	

Section	Page	Date
---------	------	------

KR-03A
Flight Manual

3	3.1 Appr. 3.2 Appr. 3.3 Appr. 3.4 Appr. 3.5 App. 3.6 App. 3.3/AUS,NZ App. 3.4/AUS,NZ App. 3.5/AUS,NZ	Nov. '90 Nov. '91 Nov. '91 Nov. '91
4	4.1 Appr. 4.2 App. 4.3 App. 4.4 App. 4.5 App. 4.6 App. 4.7 App. 4.8 App. 4.9 App. 4.10 App. 4.11 App. 4.12 App. 4.9/AUS,NZ App. 4.12/AUS,NZ	Nov. '90 Nov. '91 Nov. '91
5	5.1 App. 5.2 App. 5.3 App. 5.4 App. 5.5	Nov. '90

KR-03A
Flight Manual

Section	Page	Date
6	6.1	Nov. '90
	6.2	
	6.3	
	6.4	
	6.5	
	6.6	
	6.7	
	6.8	
	6.9	
	6.10	
	6.11	
7	7.1	Nov. '90
	7.2	
	7.3	
	7.4	
	7.5	
	7.6	
	7.7	
	7.8	
	7.7/AUS,NZ/	
8	8.1	Nov. '90
	8.2	
	8.3	
	8.4	
	8.5	
9	9.1	Nov. '90

Section

0.3 Table of Contents

General	/a non- approved section/	1
Limitations	/an approved section/	2
Emergency Procedures	/an approved section/	3
Normal Procedures	/an approved section/	4
Performance	/a partly approved section/	5
Weight and Balance	/equipment list / a non- approved section/	6
Sailplane and system description	/a non- approved section/	7
Sailplane handling, care and maintenance	/a non approved section/	8
Supplements		9

Intentionally left blank

Section 1

1.	General	1.2
1.1.	Introduction	1.2
1.2.	Certification basis	1.2
1.3.	Warnings, cautions and notes	1.2
1.4.	Descriptive data	1.3
1.5.	Three-view drawing	1.5
1.6.	Information markings	1.6

Intentionally left blank

1. General

1.1. Introduction

The sailplane flight manual has been prepared to provide pilots and instructors with information for the safe and efficient operation of the KR-03A "Puchatek" sailplane.

This manual includes the material required to be furnished to the pilot by JAR-22. It also contains supplemental data supplied by the sailplane manufacturer.

1.2. Certification basis

This type of sailplane /KR-03A/ has been approved by GILC-IKCSP in accordance with JAR-22 including Amendment 3 and the Type Certificate No. BG-153 has been issued on 19.12.1987 for Utility Category of Airworthiness.

The glider has also been approved for operation by the FAA acc. to the Type Certificate No. G65EU issued on August 6, 1991, and by the GFA acc. to the Type Certificate No. 004 issued on January 13, 1992.

1.3 Warnings, cautions and notes

The following definitions apply to warnings, cautions and notes used in the flight manual.

WARNING: means that non-observation of the corresponding procedure leads to an immediate or important degradation of the flight safety.

CAUTION: means that the non-observation of the corresponding procedure leads to a minor or to a more or less long-term degradation of the flight safety.

NOTE: draws the attention on any special item not directly related to safety but which is important or unusual.

1.4. Descriptive data

The KR-03A "Puchatek" glider is designed for basic schooling using the winch-launching or aero towing, basic aerobatics training, thermal and wave flying, hill soaring, and passenger flights as well. After the small adaptation it can be used for blind flying training or bungee-launching.

The metal monocoque structure. The cantilever wing, rectangular outline 3°swept forwards, fabric covered on its trailing portion.

The fuselage comprises the cockpit with two tandem seats. T-tail arrangement. The metal control surfaces in the trailing part fabric covered. One-piece canopy starboard hinged. Instrument panel before the front seat only. The main undercarriage with hydraulic shock-absorber is equipped with the disc brake. Front and rear fuselage portions are protected by the skids, or tail wheel. It is possible to install an additional instrument panel in the rear cockpit.

General technical data

(Metric measurements removed from original)

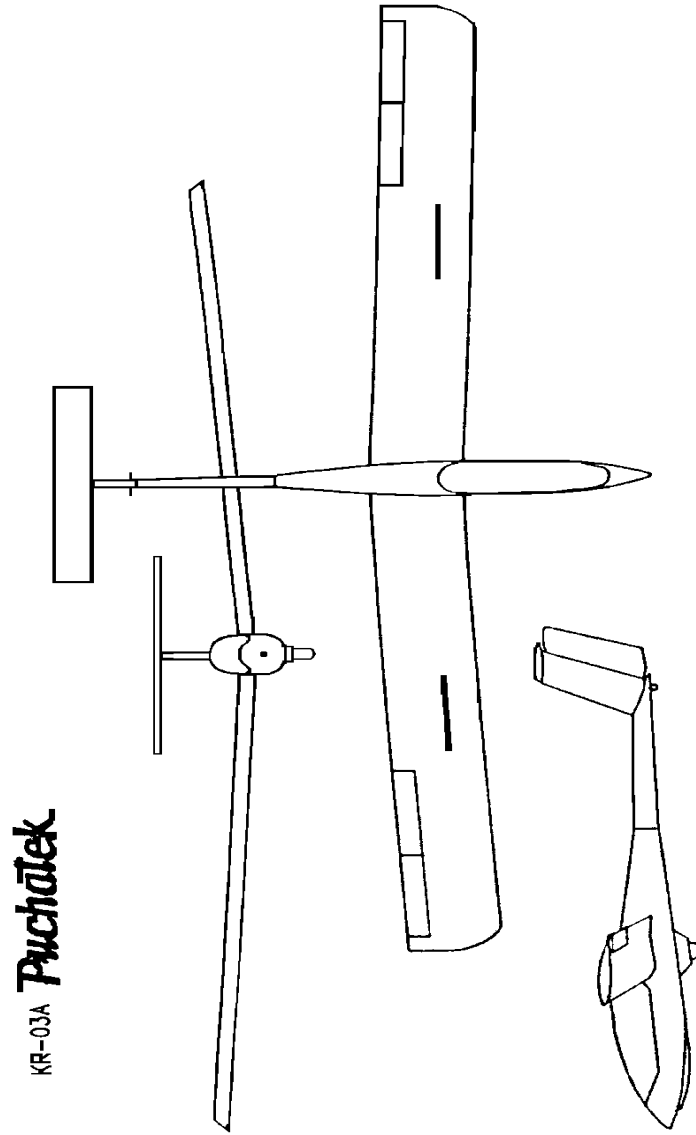

Span	53.8 ft
Length	28.3 ft
Height	5.4 ft
Wing area	209.2 sqft
Aspect ratio	13.9
Wing chord /constant/	3.9 ft
Maximum all-up mass	1190 lbs
Maximum wing loading	5.69 lbs/ft ²
Dihedral angle	4°
Sweep angle	-3°
Wing to fuselage incidence	5°
Tail plane span	11.5 ft
Wing airfoil	FX S02/1-158
Tail plane airfoil	FX 71-L-150/30
Maneuvering load factors (G)	+5.3 to -2.65

1.5 Three-view drawing





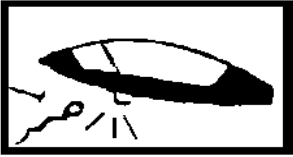

1.6. Information markings

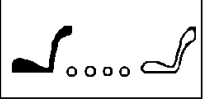
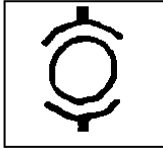

In the front and rear cockpit of the KR-03A glider the following information markings are installed:

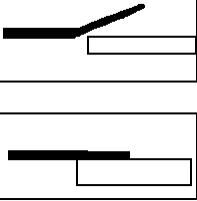
1		Longitudinal trimming	<p>Front seat on the upper wall Of the trimmer control box</p> <p>Rear seat-below the trimmer control ball in the position "tail heavy".</p>
2		Canopy emergency jettisoning	<p>Front seat- On the right cockpit board</p> <p>Rear seat- edge below the emergency jettisoning lever</p>
3	<div style="display: flex; justify-content: space-around; margin-bottom: 10px;"> EXT. RETR. </div> 	Extending of the airbrake	<p>Front seat On the left cockpit board</p> <p>Rear seat- edge systemically in the range of airbrake control lever movement.</p>
4		Towing hook	<p>Front seat- On the bottom corner of the instrument panel</p> <p>Rear seat- on the front seat above the releasing hand grip.</p>

KR-03A
Flight Manual

5		Pedals adjustment	Front seat- on the pilot's floor in the glider plane of symmetry behind the front pedals
6		Seat adjustment	Rear seat- On the right board above the rear seat fastening support
7		wheel braking	Front seat On the left board before the wheel Rear seat- brake lever support.
8		air conditioning	Front seat- On the instrument panel above the air conditioning control knob
9		ON OFF	Front seat- On the instrument panel the placard "off" above the right and left side of the turn indicator switch
10		Balancing weight	Front seat- on the left and right board before the front seat and above 1 in. over the floor.
11		luggage compartment	On the left side of the luggage compartment in the distance of about 2.8 in. in respect to the plane of symmetry and 2.8 in. in respect to the luggage compartment front

KR-03A
Flight Manual

12		First aid kit	
13		No Smoking	Front seat and Rear seat- on the right board

Section 2

2.	Limitations	2.2
2.1.	Introduction	2.2
2.2.	Airspeeds	2.2
2.3.	Airspeed indicator markings	2.4
2.4.	Color airspeed indicator markings	2.5
2.5.	Weight	2.6
2.6.	Centre of gravity	2.6
2.7.	Approved maneuvers	2.6
2.8.	Maneuvering load factors	2.7
2.9.	Flight crew	2.7
2.10.	Kinds of operation	2.8
2.11.	Aero tow, winch and bungee launching	2.8
2.12.	Limitations placards	2.10

Intentionally left blank

2. Limitations

2.1. Introduction

Section 2 includes operating limitations, instrument markings and basic placards necessary for safe operation of the sailplane.

The limitations included in this section and in Section 9 have been approved by: GENERAL INSPECTORATE OF CIVIL AVIATION-CIVIL AIRCRAFT INSPECTION BOARD/GILC-IKSP/.

Compliance with these limitations is mandatory.

2.2. Airspeeds

Airspeed limitations and their operational significance are shown below:

VNE	107 kts	Do not exceed this speed in any operation and do not use more than 1/3 control deflections
VRA	80 kts	Do not exceed this airspeed except in smooth air and then only with caution

KR-03A
Flight Manual

V _A	80 kts	Do not make full or abrupt control movement above this speed because under certain conditions the sailplane may be overstressed by full control movement
V _W	67 kts	Do not exceed this speed during winch launching
V _T	70 kts	Do not exceed this speed during aero towing
Maximum permissible speed for air brake operation and flight with air brakes extended	107 kts	Do not exceed this airspeed during airbrake operation and flight with air brake extended

Appr. 2.3



2.3. Airspeed indicator markings

Airspeed indicator markings and their color-code significance are below:

Marking	/IAS/value or range	Significance
Green arc	43–80 kts	Normal operating range (lower limit is maximum weight 1.1 VS1 at most forward C.G. and maximum weight. Upper limit is rough air speed.)
Yellow arc	80–107 kts	Maneuvers must be conducted with caution and only in smooth air
Red line	107 kts	Maximum speed for all operations
Yellow triangle	48 kts	Approach speed at maximum weight

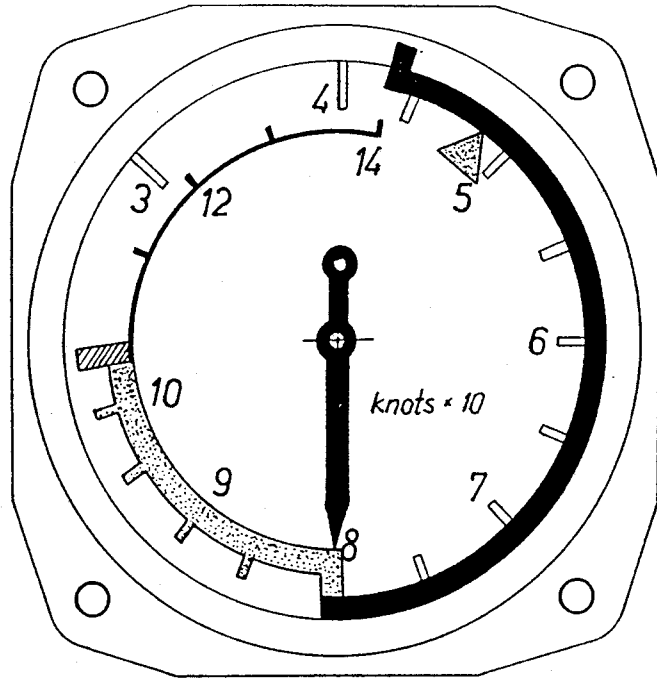
2.4. Color diagram of Air Speed Indicator



-  - Red
-  - Yellow
-  - Green

2.5. Mass /weight/

Maximum take-off mass	1190.5 lbs
Maximum landing mass	1190.5 lbs
Maximum mass of non-lifting parts	377lbs
Maximum load in the luggage Compartment (soft items only)	11lbs

2.6. Center of gravity

Allowable range of the C.G. for flight/ measured in respect to the wing root chord leading edge is:

0.223 to 1.04 ft

what corresponds the range of 21.5 to 43 percent of MAC. The above C.G. range corresponds to the permissible loadings of glider contained in section 2.9.

2.7. Approved maneuvers

The KR-03A glider is certified in the Utility Category with the following maneuvers approved:

- Loops
- Stall turn
- Spiral dive
- Climbed turn
- Lazy eight

The recommended entry speeds and the remarks on performing the above maneuvers are contained in section 2.12.

2.8. Maneuvering load factors

Maximum limit positive and negative load factors under different flight conditions are:

Positive: 5.3g at VA 4.2g at VNE

Negative: -2.65g at 73.4 kts -2.0g at VNE

2.9. Flight crew

The KR-03A glider has the following crew limitations:

- Solo flight on the front seat only,
- The front seat is for pilot or student pilot,
- The rear seat is for instructor or passenger,
- Minimum permissible load mass on the front seat (without front ballast) is 145.5 lbs
- Minimum permissible load mass on front seat (front ballast of m=21 lbs) is 121.3 lbs
- For the load mass in the glider above 220.5 lbs the use of front balancing weight is prohibited.

2.10. Kinds of operation

KR-03A glider is intended for normal sailplane-ing and performance of aerobatic maneuvers according to section 2.7. It is allowed for day flying in VFR conditions. Cloud and night flying is allowed where national operational regulations so permit.

Flying in icing conditions is prohibited.

The performing of multi-turn spinning and the schooling in the entry and recover of spinning are allowed.

2.11. Aero tow, winch-launching and bungee-launching.

KR-03A glider is intended for aero towing, winch-launching and bungee-launching.

Aero tow

For aero towing the front hook shall be used.

The recommended aero tow cable length is 131.2 to 164 feet.

The minimum length is 65.6 feet.

The strength of towing cable or safety link is required not greater than 2300 lbs \pm 10%.

Aero tow speed:

at climbing 51 to 59 kts

at cruising 65 to 70 kts

Winch-launching:

For winch launching the C.G. hook shall be used only.
The glider is allowed for take-off by means of winch coupled with the cable back-pulling device.
The winch-launching speed is
 43 to 59 kts
 and cannot be less than 43 kts.
The strength of cable safety link for winch-launching is required not greater than 2300 lbs \pm 10%.

Bungee-launching

The KR-03A glider is allowed the bungee-launching. To bungee-launch use the recognized and approved bungee catapult and releasing equipment. The hook for bungee-launching is mounted with two screws to the front ferrule of the front skid. The hook is to be mounted for bungee launching only (see 3.11 of Maintenance Manual) and it has to be removed in case of other kinds of take-off. The releasing equipment of the glider is fixed to the lug of the rear skid.
The take-off occurs at the airspeed of 31 to 36 kts.
The ground run length amounts 26 to 115 feet.
The airborning speed and ground run length depends on the glider loading and wind velocity.
The bungee-launching with a downwind component is not recommended.

2.12. Limitation placards

1. Placard of permissible airspeeds:

PERMISSIBLE AIRSPEEDS KTS	IAS
V_{NE} Maximum permissible airspeed in smooth air	107 kts
V_{RA} Maximum permissible airspeed in gust conditions	80 kts
V_A Maneuvering speed/(sharp control deflections/	80 kts
V_T Maximum permissible aero towing airspeed	70 kts
V_W Maximum permissible winch launching speed	67 kts
Maximum permissible airspeed 107 kts for airbrake operation and flight with airbrakes extended	107 kts

2. Placard of limitations:

Limitations
<ol style="list-style-type: none">1. KR-03A glider allowed for day flying in VFR conditions2. Solo flight on the front seat only3. Winch-launching on the C.G. hook only4. Flying in icing conditions prohibited5. Flights without parachutes with back cushions only

5. Placard of V_{NE} variation versus altitude,
Version (a) or (b).

a/

ALTITUDE	VNE AIRSPEED IAS
FT	KTS
00	107
4921	107
5906	106
6562	105
7218	104
7874	103
8530	102
9186	101
9842	100
10499	99
1115	98
11811	97
12467	96
13123	95

Appr. 2.12

b/

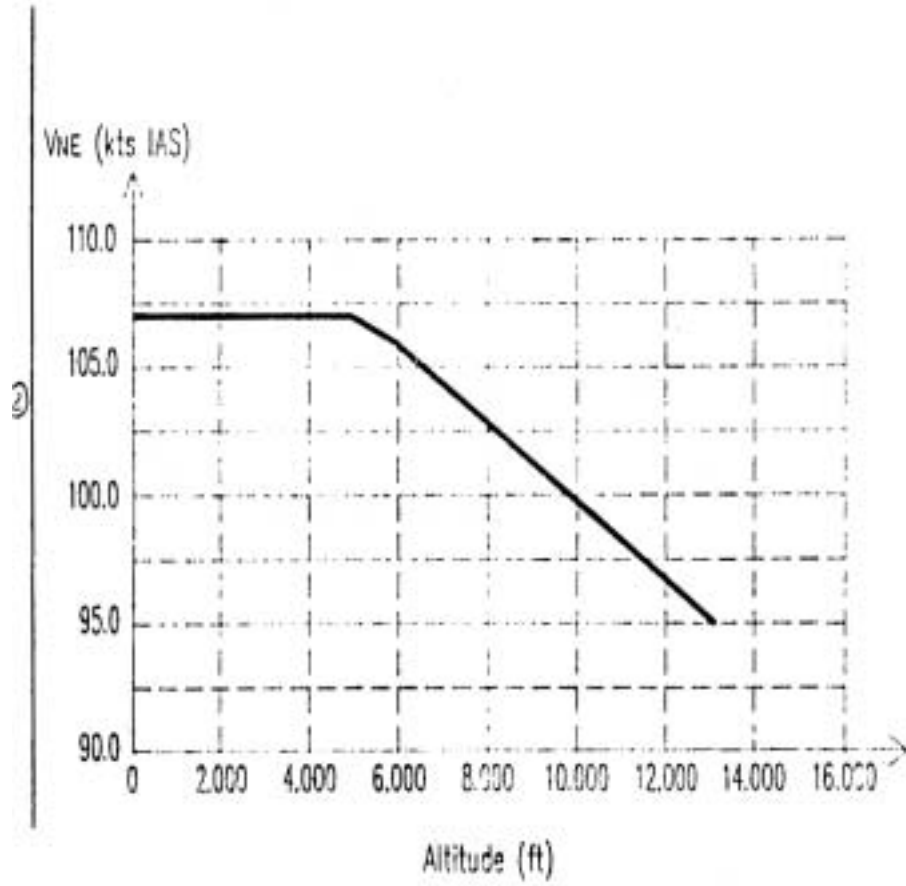

Section 3

3.	Emergency Procedures	3.2
3.1	Introduction	3.2
3.2	Canopy jettison	3.2
3.3	Bailing out	3.2
3.4	Stall recovery	3.3
3.5	Spin recovery	3.4
3.6	Spiral dive recovery	3.4
3.7	Side-slip	3.5
3.8	Fire	3.5
3.9	Other emergencies	3.5
3.9.1	Breaking or unintended towing cable releasing at low altitude	3.5
3.9.2	Flight with an incorrect trimming	3.5
3.9.3	Danger of exceeding the maximum permissible airspeed	3.6

Intentionally left blank

3. Emergency procedures

3.1. Introduction

In this section the procedures in danger and emergency conditions are described.

3.2. Canopy jettison

The procedures for the canopy jettison are the following:

1. Release the control stick.
2. Catch firmly and pull back simultaneously:
 - hand-grip of the canopy lock /with left hand/
 - hand-grip of the emergency canopy jettison /with right hand/.
3. Holding the hand-grips push the canopy upwards and jettison.

3.3. Bailing out

Bailing out and parachute using is the only way of rescue when the controlled return to the earth is impossible. In case of two persons crew the bailing out decision is taken by the ship captain. When the altitude allows the crew member not the captain bails out first. The captain exits as a second, or when he has used all the possible ways to ensure the crew member to leave the cockpit.

The procedures for bailing out is the following:

1. Jettison the canopy.
2. Release the safety harness.
3. Pull back the legs and bail out.

If the glider rotates quickly bail out towards the rotation direction.
4. Wait 3 seconds at least and open the parachute. If the exit takes place at the altitude 650 feet open the parachute immediately after exit.

If the exit occurs at the high altitude it is necessary to take into account:

1/ The possibility of climbing the pilot with parachute in strong thermals /in clouds/ and the associated dangers of oxygen lack, low temperature or icing.

2/ The danger of the body to be frozen.

In respect to the above circumstances it may be recommended to stay in the cockpit of the damaged glider cockpit /if its condition allows for / till the altitude drops into the level ensuring the safe parachute exit.

3.4. Stall recovery

Stall recovery of KR-03A is the following:

1/ Stall in straight flight with air brake retracted or extended

1. Resolutely push the stick forwards more than to neutral.

2. Accelerate the glider up to 43 kts airspeed.

The height loss in stalling at straight flight is about 230 feet.

2/ Stall in turning

1. Resolutely push the stick forward more than to neutral simultaneously gain the symmetric flight with the proper actions of elevator and rudder.

2. Accelerate the glider up to 43 kts airspeed.
The height loss in stalling from a turn is about 197 feet.

3.5. Spin recovery

KR-03A glider performs the multi-turn spin for the rear C.G. locations (34 to 43 % of MSC).

For front C.G. locations (21.5 to 34% of MSC) the spinning is recovered automatically or enters the spiral dive.

The most spinning favorable aileron is deflected towards the rotation.

The spinning of KR-03A sailplane is of steep characteristic and the recovery is easy and quick.

The recovery procedure is the following:

1. Deflect the rudder opposite the glider rotation.
2. Push the stick in to near neutral and simultaneously neutralize the ailerons.
3. Pull out of the diving with the elevator movement.

The height loss in spinning ranges about 330 feet for one turn and in recovery up to 330 feet.

3.6. Spiral dive recovery

The procedures for the spiral dive recovery are the following:

1. Using the aileron movement regain horizontal flight.
2. Using the elevator adjust the airspeed

3.7. Sideslip recovery

The procedures for the side-slip recovery are the following:

1. Put the controls into neutral position.
2. Identify the glider attitude with respect to the horizon,
3. using the elevator regain the required flight parameters.

3.8. Fire

Smoking in the cockpit is prohibited.

3.9. Other emergencies

3.9.1. Towline break or unintended towing cable release at low altitude

Observe the following procedures:

1. Release the hook/ towing cable off.
2. Regain glide flight.
3. Land taking into account the wind direction and intensity, the environment conditions and situation.

3.9.2. Flight with incorrect trim

In case of lack of front balancing (light pilot) break the flight and land on the airfield avoiding the low airspeeds.

3.9.3. Danger of exceeding the maximum permissible airspeed

In case of unintended airspeed increment creating the danger of the maximum permissible in normal flight airspeed of 107 kts open the airbrakes and then perform the proper maneuver to decrease the airspeed and regain the correct flight. The excessive stick pulling in such circumstances is prohibited.

Section 4

4.	Normal procedures	4.1
4.1.	Introduction	4.1
4.2.	Rigging and derigging	4.2
4.3.	Daily inspection	4.3
4.4.	Preflight inspection	4.4
4.4.1.	Rear seat adjustment	4.4
4.4.2.	Front pedals adjustment	4.5
4.4.3.	Preflight procedures	4.5
4.5.	Normal procedures and recommended speeds	4.6
4.5.1.	Take-off procedures	4.6
4.5.2.	Flight	4.8
4.5.3.	Approach	4.9
4.5.4.	Landing	4.10
4.5.5.	High altitude flight	4.10
4.5.6.	Flight in rain	4.10
4.5.7.	Aerobatics	4.10
4.5.8.	Side-slip	4.12

Intentionally left blank

4. Normal Procedures

4.1. Introduction

Section 4 provides checklist and amplified procedures for the conduct of normal operation.

4.2. Rigging and derigging

Rigging of wings

1. Arrange the glider components (fuselage, wings, tailplane) in the position most favorable for rigging.
2. Remove the bolts out of the main framework and rear fitting block.
3. Lift the wing and insert the wing main fittings into the fuselage framework lugs and simultaneously pay attention to the correct location of the rear fitting in the lug of the rear fitting block.
4. Centralize the holes for main bolts, insert the bolts and slightly screw in.
5. Insert the rear bolt, screw on and secure the nut of rear bolt. Screw in the inspection hole cover.
6. Tighten the main bolts.
7. Use the same procedures for the second wing.
8. Move resolutely the wing tips “up-down” and “forwards and backwards” several times.

9. Tighten the main bolts with a torque of 17.7 lb-ft (24 Nm) and secure with wire /each bolt separately/.

10. Connect the control systems of air brake and aileron. Derigging requires the inverted sequence.

Rigging of tailplane

1. Remove the safety pins, screw off the nuts and remove the washer out of the rear pivots of the stabilizer.

2. Lift the stabilizer and insert the stabilizer fittings on the fin fittings pushing the stabilizer till to stop.

3. Put on the washers on the rear pivots, screw in the nuts till to stop. Secure the nuts with safety pins.

4. Connect the elevator control system.

5. Check the correct connection and elevator operation. Put on the fairing and screw in the fastening screws.

Derigging requires the inverted sequence.

A detailed description of rigging and derigging procedures is contained in the Maintenance Manual, Section 3.

4.3. Daily inspection

Before the flying day it should be checked:

1. Validity of glider documents.

2. Integrity of the structure and coverings.

3. Securing of rigging elements and control system connections.
4. Operation of control systems.
5. Operation of towing hooks.
6. Closing and opening of the canopy and the condition of the cable supporting the canopy in the opened position.
7. Condition of undercarriage, wheel rollability, pressure in the tire /deflection of about 1in/.
8. Fixing of the rear seat and back-rest.
9. Pilots' safety belts.
10. Total and static pressure heads.
11. Airspeed indicator operation /it should react on the blows into the heads/.
12. Turn indicator operation.

4.4. Preflight inspection

4.4.1. Adjustment of the rear seat

The rear seat in the loaded condition may be reset in the following way:

1. Open the canopy.
2. Turn the carrying tube to left till it is released out of the fitting.
3. Adjust the seat into the required position and turn the carrying tube into its initial position.

4.4.2. Adjustment of the front pedals

The adjustment of the front pedals is carried on as follows:

1. Put the legs onto the pedals..
 2. Release the pedal locking means of pulling the adjusting tension member.
 3. Adjust the pedals in required position by pulling or pushing them with legs.
 4. Release the adjustment tension member.
- Check the correct pedal locking.

4.4.3. Preflight procedures

1. In case of flights without parachutes the seats must be equipped with back cushions which are supplied by the manufacturer with the glider.
2. Balance the glider with the weights according to the loading mass. Check the weights to be correctly fixed.
3. Adjust the rear seat. For solo flight the rear pilot belts shall be fastened together.
4. Take place in the cockpit, adjust the pedals, and fasten the belts.
5. Make the full movements of control surfaces, air brake, and trimming device. Put the trimming slider according to the take-off kind and crew mass.
6. Check the turn indicator operation.
7. Close the canopy.
8. Connect the towing cable and check the coupling pulling the cable several times firmly /surging/.

4.5. Normal procedures and recommended speeds.

General control characteristics of KR-03A glider

KR-03A glider is correct and easy in controlling with the behaviors similar to the training types. It features:

1. Short ground run at take-off
2. Good lateral and directional controllability
3. Safe behavior at low airspeed without the tendency to automatically entering the spin.

4.5.1. Take-off procedures

Aero towing take-off and towed flight

For aero towing the front hook shall be used.
Before take-off the towing cable should be hooked and tensioned.

Put the trimming slider into the position:

- solo flight- between "neutral" and "nose heavy"
- heavy crew- "neutral"

During the ground run at the speed of 16-22 kts adjust the glider attitude /lift the tail or nose depending on the crew mass/ by slight pushing or pulling the stick. Depending on the total mass airborning occurs at 35 to 38 kts.

When the airspeed is stable the trimming should be corrected.
The recommended towing speeds are given in Section 2.11.

Winch-launching

For winch launching the C.G. hook shall be used only. The glider should be positioned in line with cable direction. The small deflection to the left of the above line is allowed. Before the take-off position the trimming slider into the position:

- light crew: nose heavy between 8 to 11 slots
- heavy crew: tail heavy between 4 to 7 slots

The correction of trimming during take-off is not recommended. The take-off process of KR-03A does not differ in any essential way from the winch-launching of other gliders. The ground run is short and depends on the crew mass and wind intensity.

The ground run and near ground flight should be performed with the stick pushed forward of neutral to avoid tail impact on ground at the moment of take-off. When the altitude of 50 to 65 feet is gained pass smoothly into the climb.

In the final section of climbing to obtain the correct flying path the stick should be pulled to the required position.

Before the cable release the stick should be pushed and the cable release hand-grip pulled /two times to be sure that the cable is released/.

The recommended winch-launching speed is given in Section 2.11.

Bungee-launching

Before the bungee-launch the following conditions must be performed:

1. Make the bungee cables spacing symmetrically to the longitudinal axis of the glider/angle of flare 30° to 35°.

2. Position the trim slider as follows:

light crew - nose heavy on 5th slot

heavy crew - tail heavy on 4th slot

Adjusting the trim during the take-off is not recommended.

Using the controls during the take-off is not practically necessary.

Glider keeps direction and lateral stability.

After take-off accelerate the glider up to 43 to 46 kts and continue the flight.

The Bungee catapult's stretching requirements are

-12 people if wind velocity is greater than 2m/s

-16 person with heavy crew and no-wind conditions.

4.5.2. Flight

Free flight

The trimming device allows the glider to be trimmed in the below given airspeed range:

-light pilot from about 32 to 81 kts

-heavy crew from about 38 to 97 kts

Before the flight the pilot should be familiar with the speed polar given in section 5.3.

Circling

The circling behaviors of the KR-03A gliders are correct. The lateral controllability is good. The recommended thermaling airspeeds are 35 to 43 kts depending on loading, bank angle, and the thermal characteristics.

Flight with airbrake extended

The airbrake of KR-03A limits the diving airspeed to the permitted value and allows for controlling the approach angle. The air brake may be operated at airspeeds up to VNE with no danger of damaging the structure. For the glider without a spring in the airbrake control system, forces in excess of 45 lbs may arise when retracting airbrakes.

4.5.3. Approach

The approach of the KR-03A is correct and safe. Basically the landing should be performed against the wind but if necessary case it may be performed the landing with the side wind component of up to 8 kts, or rear wind of 6 kts.

Recommended approach airspeeds:

- in smooth air 43 to 48 kts
- in gusty conditions 46 to 51 kts depending on the loading.

The approach angle should be controlled by means of airbrake.

4.5.4. Landing

The landing procedure of KR-03A glider is the standard one. Depending on the glider mass and airbrake extending degree the ground touching occurs at about 35 to 38.8 kts airspeed.

It is recommended to touch down with the airbrakes partially extended.

The length of the landing ground-run in windless conditions is:

- without wheel braking, 295 to 328 ft

-with wheel braking, 197 to 262 ft
depending on the loading.

4.5.5. High altitude flight

KR-03A glider is permitted for altitude flying according to the national regulations and equipment.

4.5.6. Flight in rain

The flights of the KR-03A glider in rain are not recommended, however due to the large canopy the good visibility in rain is ensured. In case of poor visibility through the canopy perspex the window on the left side should be opened. Location of the window ensures the correct controlling of the flying path.

4.5.7. Aerobatics

Before the take-off for aerobatic flying it is necessary to:

1. Check the correct balancing with the weights /concerning solo flight.
2. Remove the free objects out of the cockpit.
3. Check the securing of the supporting tube of the rear seat.
4. Check the full deflections of the control stick and pedals with the safety belts fastened.
5. In case of solo flight, fasten the rear seat safety belts and remove the useless pillows.

During the flight immediately before performing the aerobatics:

1. Fasten the back belts.
2. Trim the glider to 59 to 65 kts.
3. Check the correct canopy and airbrake locking.
4. Shut the window and air conditioning intake.

The maneuvers in KR-03A gliders are to be performed as follows:

1. Looping, stall-turn, spiral in conventional manner.
2. Climbed turn- at the entry airspeed of 92 to 97 kts make the sharp pulled turn with 45° bank in such a way that in recovery on the back direction /180°/ the airspeed is 37.7 to 43 kts.

3. Lazy eight- at the entry airspeed of 75.5 to 91.7 kts make the sharp pulled turn with 45° bank in such a way that after the direction reversal by 180° the airspeed is about 43 kts. After the next 45° recover the glider out of the turn and gain once more the airspeed of 75.5 to 91.7 kts and repeat the same maneuver in the opposite direction and recover into the original direction. The entry airspeeds for the particular aerobatic maneuvers are given in section 2.12.

4.5.8. Side-slip

The side-slip entry airspeed is 43 to 48.5kts.
The procedures for performing the side-slip are the following:

1. Bank the glider into the wind.
2. Prevent the glider to turn by means of rudder deflection.

The airspeed indications in the side-slip are not the true ones. When entering the side-slip, the airspeed indications rapidly drop down to 21.5 to 27 kts and when the side-slip becomes stable the indicated airspeed increases to 37.7 to 40.5 kts depending on pitch and bank attitude of the glider.

Section 5

5.	Performance.	5.2
5.1.	Introduction.	5.2
5.2.	Approved data.	5.2
5.2.1.	Airspeed indicator system calibration	5.2
5.2.2	Stall speeds	5.3
5.3.	Additional information	5.4
5.3.1.	Demonstrated crosswind performance	5.4
5.3.2.	Speed polar	5.5

Intentionally left blank

5. Performance

5.1. Introduction

Section 5 provides approved data for glider performance, stall speed, and non-approved glider information. The data in tables and diagrams has been computed from actual flight tests with the glider in good condition and using average piloting technique.

5.2. Approved data

5.2.1. Airspeed indicator system calibration

The aerodynamic correction diagram /averaged/

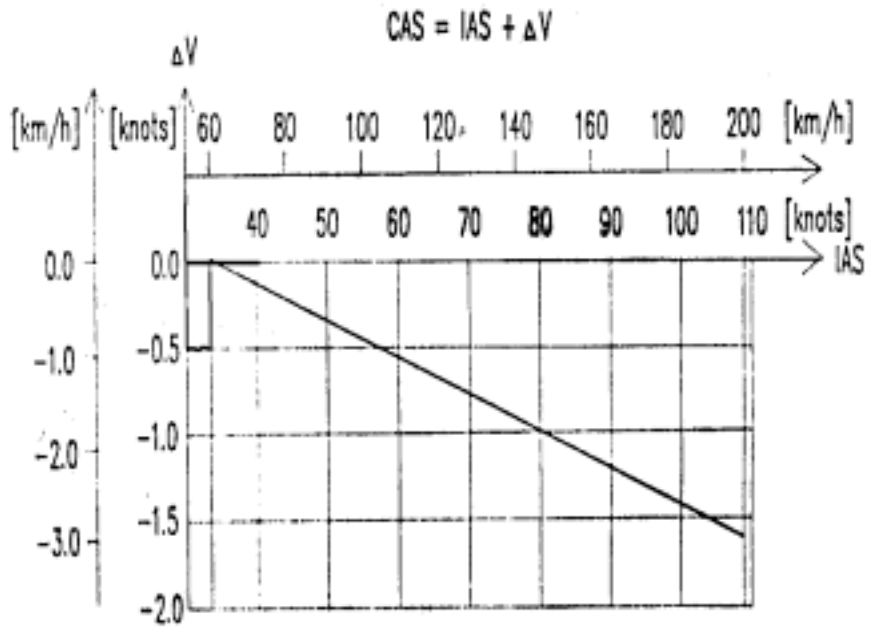

5.2.2. Stall speeds

The straight flight stall speed of the KR-03A glider depends on:

- all up mass
- C.G. location in glider

It ranges from about 31 kts for the minimum crew mass to about 39 kts for the all up mass.

The stall speed in a turn is slightly higher and depends on the bank angle it ranges for:

- light pilot about 33.4 to 35 kts
- heavy crew about 41 to 43 kts

Both in straight and turning flight with airbrakes extended the stall speed depends on the glider's mass and is greater by about 5 kts than the stall speed for smooth configuration.

The KR-03A glider warns the approach to stall by means of fuselage vibrations which appear at about 3 kts before the stall occurs.

The stall in flight with airbrakes extended is of similar characteristics as for the smooth configuration. The only important difference is that due to the airflow perturbation caused by the extended airbrakes the structure vibrations appear.

These vibrations are separate from the vibrations which give warning of the approach of the stall.

Stall characteristics are safe. Flight with the stick pulled full is possible.

The variation of stall speed versus glider mass is plotted below:

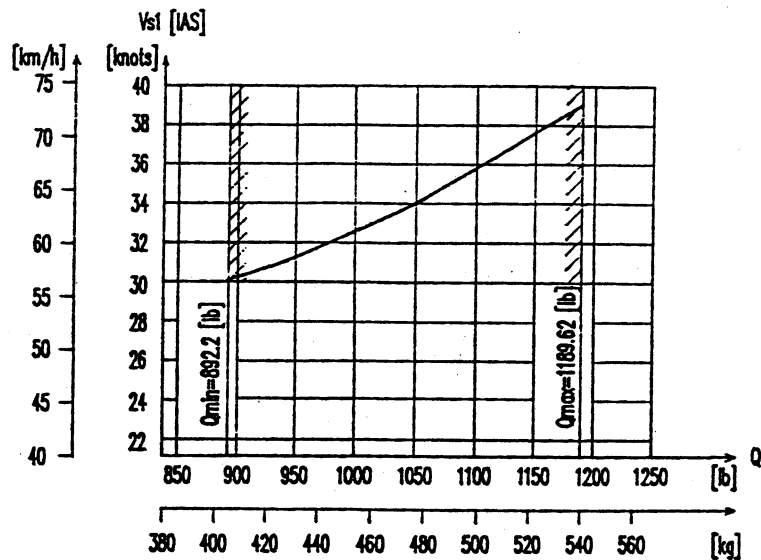

NOTE: The stall speed depends on the glider mass and C.G. location. On the diagram the function of V_{s1} versus glider mass is plotted. For a given mass the variable C.G. position is possible depending on the pilot's mass on front and rear seat. For the cockpit loadings where the second seat pilot's mass is higher than the pilot's mass in front seat the airspeed V_{s1} increases slightly when compared with this one on the diagram

5.3. Additional information

5.3.1. Demonstrated crosswind performance

The allowable crosswind component is 8 kts and the take-off in this conditions does not require the exceptional pilot's skill. The above concerns the aero tow and winch-launching as well.

5.3.2. Speed polar

Speed polar is plotted below

5.3.2. Speed polar

Speed polar is plotted below

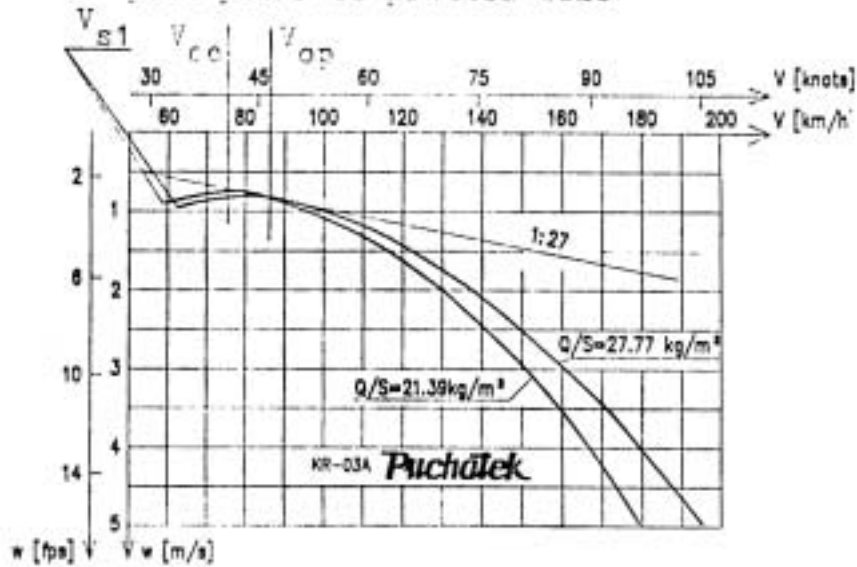

Speed polar of KR-03A "Puchatek" glider

On the speed polar diagram the specific points are noted stall speed for the maximum and minimum crew mass. The economic and optimum airspeeds are noted for average load value. V_{ec} , V_{op} .

(The speed polar shows 1:27 best glide ratio.

V_{S1} is marked at 32 kts for 917 lbs

and 34 kts for 1190 lbs gross weight. Min sink ($V_{economy}$) is 41 kts.

Best glide ($V_{optimum}$) is 47 kts.

Section 6

6.	Mass /weight/ and balance	6.2
6.1.	Introduction	6.2
6.2.	Empty glider mass and moment in the basic configuration	6.2
6.3.	Mass of non-lifting parts	6.3
6.4.	Glider mass	6.4
6.5.	Useful load	6.4
6.6	C.G. location envelope	6.4
6.7.	Equipment list	6.10

Intentionally left blank

6. Mass /weight/ and balance

6.1. Introduction

This section describes the procedures for establishing the basic empty mass and moment of the glider, the graphical checking of C.G. weighing table and list of equipment.

The empty glider weighing procedures are described in Maintenance Manual of KR-03A glider, section 3.9.

The range of C.G. locations of the empty glider with the basic equipment measured aft of the root rib leading edge is

b = 1.719 to 1.876 feet.

6.2. Empty glider mass and moment in the basic configuration

Weighing table of KR-03A glider.

Serial No: 03-14

Mass of empty glider with basic equipment m_{st} /lbs	341.7 kg	753.3 lbs
--	-------------	--------------

Location of C.G. of empty glider with basic equipment in respect to root rib leading edge b /ft/	0.547 m	1.79 ft
--	------------	------------

Moment of empty glider with basic equipment with respect to root rib leading edge $M_{st}=540-m_{st}$ /lbs/	187.0 kg-m	1353.9 lbs-ft
---	---------------	------------------

Maximum permissible load Mass $m_{load}=540-m_{st}$ /lbs/	198.3 kg	437 lbs
---	-------------	------------

Date, signature and seal of the inspection:
dated 92-05-06

The mass of the empty glider with basic equipment should range 749.5 and 771.6 lbs and the moment 1288.4 and 1447.5 lbs-ft.

6.3. Mass of non-lifting parts

The non-lifting parts are fuselage with:

-tailplane	33.0±1.1 lbs
-rudder	7.7±0.66 lbs
-canopy	27.5±0.66 lbs
-rear seat	12.1±0.44 lbs
-front seat	9.2±0.44 lbs
-instrument panel	6.6±0.44 lbs
-main wheel with undercarriage arm	16.0±0.44 lbs

Maximum mass of all non-lifting parts is 377 lbs.

6.4. Glider mass

Maximum permissible glider mass	1190.5 lbs
Minimum wing mass	379.0 lbs
Front balancing weights mass	21.0 lbs

6.5. Useful load

Maximum useful load is understood as a difference between the all up mass of the glider 1190.5 lbs, and its real empty mass.

Maximum pilot + parachute mass: 242.5 lbs

Minimum pilot + parachute mass: 121.25 lbs

6.6. C.G. locations envelope

Before the flying and before the every change of load condition the C.G. location should be checked.

The procedures are:

1. On the vertical axis of the diagram on page 6.10 find the glider mass value calculated from the formula:

$$m = m_{st} + m_1 + m_2 + m_w$$

where:

m_{st} -mass of the empty glider with basic equipment (see page 6.3)

m_1 , m_2 -mass of front and rear pilots /with parachute or back cushion/

m_w - sum of the masses of additional equipment and balancing weights installed

2. On the horizontal axis of the diagram on page 6.10 find the moment value calculated from the formula:

$$M = M_{st} + M_1 + M_2 + M_w$$

where:

M_{st} -empty glider moment /see table page 6.3/

M_1, M_2 - moments of the front and rear pilots /with parachute or back cushion/

M_w -sum of the moments of additional equipment and balancing weights installed. /see page 6.11/.

NOTE: In the moment sum pay attention to the moment sign /positive or negative/ of every particular moment.

3. From the points found in item 1 and 2 draw in the lines perpendicular to the axes of the diagram and find the intersection point. If this point is located inside the dashed area the glider C.G. is in the correct location. In other case the balance should be corrected with the weights and repeat the checking procedure.

Example:

The checking of correct C.G. location

1. Empty glider data: /real data, as the example, see page 6.3

$m_{st} = 760$ lbs

$M_{st} = 1388.7$ lb-ft

2. Crew /see page 6.8and 6.9 /.

-front seat $m_1 = 154$ lbs
 $M_1 = -549.7$ lb-ft
-rear seat $m_2 = 176$ lbs
 $M_2 = -72.3$ lb-ft

3. Additional equipment /see page 6.11

WES-5 variometer: 2.86 lbs -14.4 lb-ft

RS-6101 transceiver: 7.9 lbs +21.7 lb-ft

$$m_w = 10.76 \text{ lbs; } M_w = +7.31 \text{ lb-ft}$$

4. Glider mass in flight:

$$m = 760 + 154 + 176 + 10.76 = 1100.76 \text{ lbs}$$

5. Moment in flight:

$$M = 1388.7 - 549 - 72.3 + 7.3 = 774 \text{ lb-ft}$$

The lines perpendicular to the diagram axes drawn through the points of $m=1100.76$ lbs and $M=775$ lb-ft intersect at point "P" which is contained in the dashed area. So the C.G. location is correct.

KR-03A
Flight Manual

	Moment of front seat pilot's mass in respect to the root rib leading edge M ₁ /lbft : M ₁ /kgm/						
19.8 /9/	-455.7 /-63/	-549.7 /-76/	-622 /-86/	-716 /-99/	-788.4 /-109/	-875 /-121/	-
17.6 /8/	-448.5 /-62/	-542.5 /-75/	-614.8 /-85/	-708.8 /-98/	-781 /-108/	-869 /-120/	-
15.4 /7/	-441 /-61/	-535 /-74/	-607.6 /-84/	-694 /-96/	-744 /-107/	-860.7 /-119/	-
13.2 /6/	-431.0 /-60/	-528 /-73/	-593 /-82/	-687 /-95/	-766.7 /-106/	-853.5 /-118/	-
11.0 /5/	-426.7 /-59/	-520.7 /-72/	-585.8 /-81/	-680 /-94/	-752 /-104/	-846.2 /-117/	-
8.8 /4/	- /	-513.5 /-71/	-578.6 /-80/	-672.7 /-93/	-745 /-103/	-831.8 /-115/	-
6.6 /3/	- /	-506.3 /-70/	-571.4 /-79/	-669.4 /-92/	-737.7 /-102/	-825 /-114/	-
4.4 /2/	- /	-499 /-69/	-564 /-78/	-658 /-91/	-730.5 /-101/	-817.3 /-113/	-
2.2 /1/	- /	-491.8 /-68/	-556.9 /-77/	-651 /-90/	-723.3 /-102/	-810 /-112/	-
0 /0/	- /	-477.4 /-66/	-549.7 /-76/	-614.8 /-89/	-716 /-99/	-802.8 /-111/	-822.4 /-122/
m ₁ lbs m ₁ /kg/	110.2 /50/	133.2 /60	154.3 /70/	176.4 /80/	193.4 /90/	220.4 /100/	242.5 /110/
m ₁ -mass of pilot and parachute or back cushion							

KR-03A
Flight Manual

	Moment of rear seat pilot's mass in respect to the root rib leading edge M_2 -lbft :M2/kgm/						
19.8 /9/	-43.4 /-6/	-50.6 /-7/	-72.3 /-10	-79.5 /-11/	-79.5 /-11	-72.3 /-10/	-
17.6 /8/	-43.4 /-6/	-50.6 /-7/	-72.3 /-10	-79.5 /-11/	-79.5 /-11/	-72.3 /-10	-
15.4 /7/	-43.4 /-6/	-50.6 /-7/	-72.3 /-10	-72.3 /-10	-79.5 /-11/	-72.3 /-10	-
13.2 /6/	-43.4 /-6	-50.6 /-7	-72.3 /-10	-72.3 /-10	-79.5 /-11/	-72.3 /-10	-
11.0 /5/	-43.4 /-6/	-50.6 /-7	-72.3 /-10	-72.3 /-10/	-79.5 /-10/	-65 /-9/	-
8.8 /4/	-	-50.6 /-7/	-72.3 /-10	-72.3 /-10	-72.3 /-10	-65 /-9/	-
6.6 /3/	-	-50.6 /-7/	-65 /-9	-72.3 /-10	-72.3 /-10/	-65 /-9/	-
4.4 /2/	-	-50.6 /-7/	-65 /-9	-72.3 /-10	-72.3 /-10/	-65 /-9/	-
2.2 /1/	-	-43.4 /-6/	-65 /-9/	-72.3 /-10/	-72.3 /-10	-65 /-9/	-
0	-	-43.4 /-6/	-65 /-9/	-72.3 /-10/	-72.3 /-10	-65 /-9/	-72.3 /-10/
m_1 -lbs m_2 /kg/	110.2 /50/	133.2 /60/	154.3 /70/	176.4 /80/	193.4 /90/	220.4 /100	242.5 /110/
m_2 – mass of pilot and parachute or back cushion							

Graphical checking of in-flight C.G location

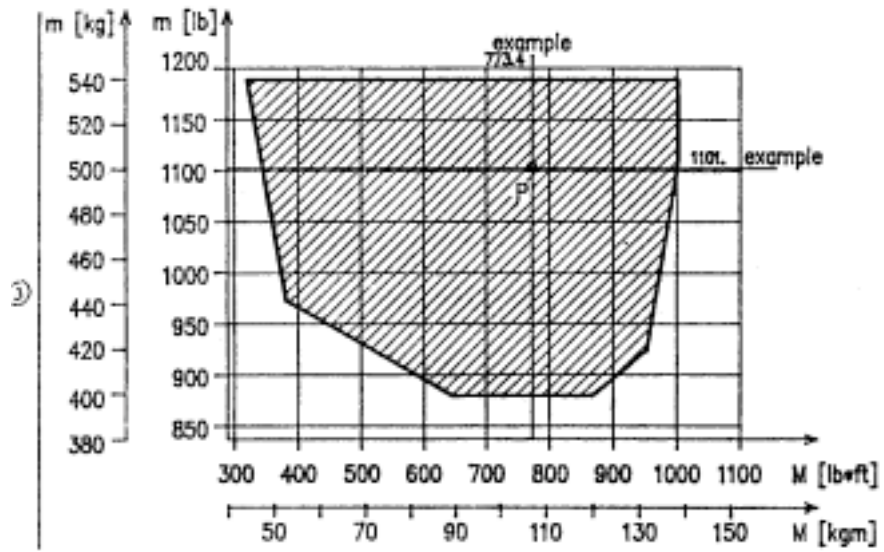

6.11. Equipment list

The items marked with X are contained in the basic empty glider mass as given in section 6.2.

The items marked with 0 are not contained in the basic empty glider mass but can be delivered together with the glider.

KR-03A Flight Manual

Mandatory	Optional	Part	No of Part	Mass Lbs/kg	ARM Ft/m	Moment Lbft/kgm	Date Of Inst.		Date of appr.
		Instrument Panel Equipment							
X		Airspeed Indicator	PR-250S	0.9	-5.58	-4.9			
X		Altimeter	W-12S,PW-12-FK	1.3	-5.58	-7.3			
X		Variometer	PR-03,WRS-5D	0.5	-5.58	-2.8			
X		Compensator	KWEC-2	0.2	-5.58	-1.2			
X		Compensator bottle	TM-420C	0.8	-5.58	-4.4			
X		Slip and turn indicator	EZS-3,EZS-4	0.7	-5.58	-4.0			
X		Compass	BS-1	0.44	-5.58	-2.5			
	o	Electric variometer	WES-5	2.86	-5.58	-1.6			
X		Front towing hook	TOST E-85	1.2	-7.2	-8.6			
x		C.g towing hook	TOST E-88	1.5	-2.0	-3.0			
X		Safety belts, front seat	J5-00-00	2.9	-3.0	-8.6			
X		Safety belts, rear seat	J5-00-00	2.9	-0.3	-0.9			
		First aid kit/empty/	CT.U1.00.00	0.66	2.6	1.7			
X		Front seat cushion	AB.72.010.00.01	2.2	-0.3	-6.6			
x		Rear seat cushion	AB.72.09.00.01	2.6	-0.3	-0.8			
	o	Front right balancing weight	AB.87.300.00.01	10.5	-4.0	-42			
	o	Front left balancing weight	AB.87.200.00.01	10.5	-4.0	-42			
	o	Front side pocket	AB.72.013.00.00	0.44	-4.6	-2.0			
	o	Rear side pocket	AB.72.014.00.00	0.44	-2.6	-1.2			
	o	Transceiver	RS-6101.1	7.9	2.6	20.5			
	o	Additional instrument panel	AB.71.200.00.00	4.0	-2.6	-10.4			

KR-03A
Flight Manual

Intentionally left blank

Section 7

7.	Glider and systems description	7.2
7.1.	Introduction	7.2
7.2	Airframe	7.2
7.3	Flight controls	7.3
7.4.	Airbrake system	7.4
7.5.	Landing gear system	7.5
7.6.	Seats and safety harness	7.5
7.7.	Luggage compartment	7.5
7.8.	Electrical system	7.6
7.9	Pitot and static system	7.7
7.10.	Miscellaneous equipment	7.8
7.10.1.	Balancing weights	7.8

Intentionally left blank

7. Glider and systems description

7.1. Introduction

This section provides the information on the glider and operation of its systems.

7.2. Airframe

KR-03A glider is all-metal cantilever design with mid-wing and T-tail arrangement. The seats are of tandem location.

WING: In two panels, rectangular with laminar Wortman's profile FX-S02/1-158. Metal structure, main and auxiliary rear spars. Trailing portion fabric covered.

AILERON: Metal structure, two panels, fabric covered suspended on four hinges.

TAILPLANE: One piece stabilizer, metal structure fixed in three points on the fin. Elevator of metal structure, two panels, fabric covered.

FIN and RUDDER: Fin integral with fuselage. Rudder of metal structure, fabric covered.

FUSELAGE: All metal, two frames of central part the front one in the main spar plane, the rear one in the auxiliary spar plane.

KR-03A
Flight Manual

COCKPIT: Covered with one piece canopy hinged on right board on two hinges, in opened position supported with cable, which during canopy closing is automatically pulled to the cockpit inside. The controls of both seats are coupled. The control operation is a conventional one.

Location of hand-grips:

Control	Location	Color
Slider of air brake	left side	blue
Hand- grip of wheel brake	left side	orange or black
Slider of trimming device	left side	Green
Hand-grip of towing Cable releasing	left side	yellow
Lock of canopy	left side	red
Emergency canopy jettison	right side	red sealed

The cockpit is air conditioned independently for each seat by means of the side windows in the perspex. Moreover the front seat has the adjustable air-blow for the front region of perspex above the instrument panel controlled with the hand-grip /black ball/ in the instrument panel.

Before the front seat the nests for balancing weights of total mass 21lbs are provided.

7.3. Flight controls

All the flight controls in the KR-03A glider are doubled.

Controlling with rudder.

Cable control system. Adjustable front pedals, fixed rear pedals. Adjustable stops on front and rear pedals, fixed stops on the rudder.

Controlling with elevator

Push-rod control system equipped with deflection stops. The conventional controlling by means on central control stick.

Controlling with aileron

Push-rod control system. The fixed stop in the wing and adjustable stops in the cockpit. The ailerons are non-symmetrically deflected.

Controlling with trimming device

KR-03A glider is equipped with spring trim actuated by push-rod system. Controlled at front and rear seat. The stop is located only at the front seat.

7.4. Airbrake system

The airbrake employs the single plates

extended on upper and lower wing surface, equipped with spring-loaded metal caps.

The combined push-rod and cable control system. The retracted position is locked by means of "dead point."

7.5. Landing gear system

One wheel, one trace landing gear.

Main wheel is of 350mm diameter by 135mm size with a disc brake. Oleo-pneumatic shock absorber. Rear skid with rubber disc. Front skid of wooden-composite structure secured with metal sheet on the bottom with rubber disc as the shock absorber.

7.6. Seats and safety harness

Fixed front seat and rear seat and in ground adjustable rear seat /four locations/. The seats are provided for parachute or back cushion which size, thickness, and compressibility are similar to those of parachute. Both seats are equipped with four part safety harnesses /two back and two abdomen belts/.

7.7. Luggage compartment

Luggage compartment is located behind the rear seat in the fuselage central part. It is provided for carrying the pilot's dress. Optionally it is possible to install the transceiver in the luggage compartment.

7.8. Electrical system

The electrical system concerns the EZS-4 turn indicator installation.
The correct battery polarity must be observed obligatory.
In other case the indications will be error.

Scheme of turn indicator installation:

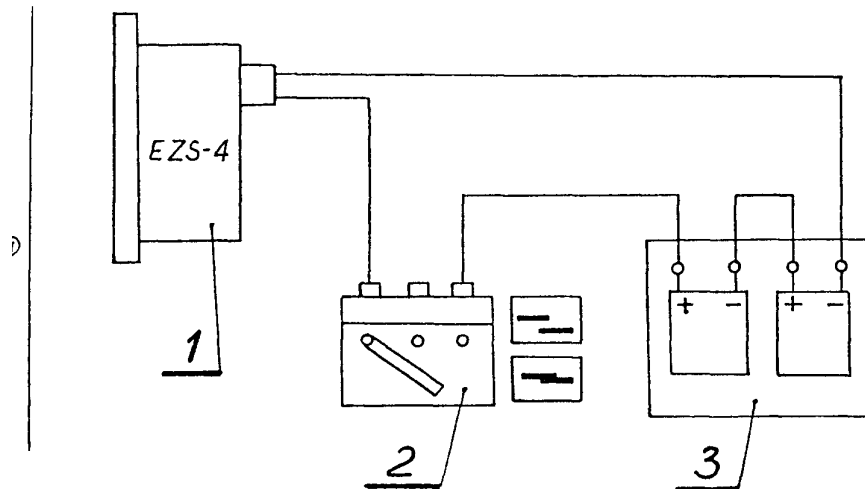

1. EZS-4 turn indicator
2. Switch on the instrument panel
3. Nest for two 4.5 v batteries connected in series

7.9. Pitot and static system

Pitot and static system of KR-03A glider

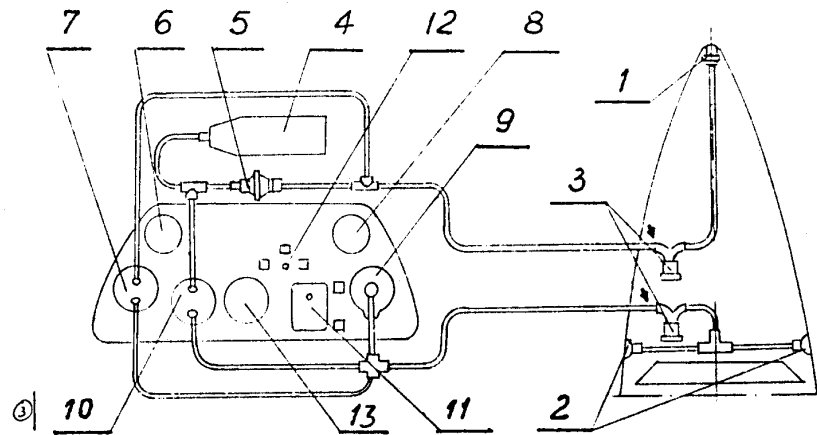

with basic equipment is shown below:

Board instruments installation:

1. –total pressure
2. –static pressure head
3. –drainage unit
4. –compensation bottle
5. –compensator
6. –turn indicator
7. –airspeed indicator
8. –compass
9. –altimeter
10. –variometer
11. –nest for turn indicator batteries
12. turn indicator switch
13. free place for an instrument

NOTE: Arrows show the ends of drainage unit 3 which should be disconnected to drain the condensate.

7.10. Miscellaneous equipment

7.10.1. Balancing weights

To balance the glider crew according the table of permissible loads in section 2.12, the KR-03A glider is equipped with two balancing loads of total mass 21 lbs.

To install the weights screw in till to stop the screws on the weight into the nest on the floor under the front seat.

Screw in with the hand force. Do not use tools.

The weights are not interchangeable one with other.

Intentionally left blank

Section 8

8.	Glider handling, care and maintenance	8.2
8.1.	Introduction	8.2
8.2.	Glider inspection periods	8.2
8.3.	Ground handling	8.2
8.4.1.	Airfield transportation	8.3
8.4.2.	Road transportation	8.3
8.5.	Cleaning	8.3
8.5.1.	Procedures after flights	8.3
8.5.2.	Cleaning	8.4
8.5.3.	Maintenance	8.5

Intentionally left blank

8. Glider handling, care and maintenance

8.1. Introduction

This section contains manufacturer's recommended procedures for proper ground handling and servicing of the glider. It also identifies certain inspection and maintenance requirements which must be followed if the glider is to retain the new-plane performance and dependability. It is wise to follow a planned schedule of lubrication and preventative maintenance based on climatic and flying conditions encountered.

8.2. Glider inspection periods

Range of procedures to be performed immediately before take-off are listed in section 4 of this manual. The time schedule for inspections of KR-03A glider and the procedure range for particular inspections are given in section 4 of the Maintenance Manual.

8.3. Glider repairs

The range and way of performing the repairs allowed to be done by the user himself are listed in Repair Manual for KR-03A glider. The list of materials for repairs is enclosed therein.

8.4. Ground handling

8.4.1. Airfield transportation

During the airfield transportation the canopy should be closed and the window opened. The air brake may be extended or retracted. The glider (with or without the crew) may be transported using the front hook to allow for free turning. The transportation cable length should be at least 13ft. The glider can be also rolled on the wheel forwards or backwards.

8.4.2. Road transportation

The glider can be transported on the universal trailer. The information on preparing the glider for transportation and location on the trailer is given in section 3.6 of the Maintenance Manual.

8.5. Cleaning and care

8.5.1. Procedures after flights

After the flight it is necessary to:

- switch off the turn-indicator and replace, if necessary, the exhausted batteries,
- drain the board instruments air system, if necessary,
- perform the glider inspection same as before the flights and remove the eventual faults.

8.5.2. Cleaning

Plug all openings and pay special attention to the static pressure holes before the start of cleaning procedure. Clean with water; add 3 to 5 percent of detergenting agent. The use of cleaning powders is prohibited. To remove the dust or bugs on the leading edges the neutral soap should be used applied with a sponge. Then rinse with clear water carefully to remove all the soap.

Cleaning of cockpit and perspex

The cockpit and perspex when cleaned with usual means are exposed for scratches which result in degradation of transparency and accelerate the wear. Therefore pay the special attention. Use only clear water or cleaning agents applied for perspex, rags of very clean flannel, and sponge. Be sure that no sand or dust particles are present on the sponge or flannel.

Cleaning of the cockpit interior

Seats, pillows and floor should be cleaned with a vacuum cleaner and washed using water with soap. The pillows can be cleaned with commonly applicable means for cleaning.

Cleaning of corrosion

In any place where corrosion occurs in form of spots or affected surface the following means

of careful should be applied:

1. Clean thoroughly the corrosion affected surface using the brush, sand paper of 600 grate and kerosene.
2. Using the vacuum cleaner remove all dust or oxidation created when cleaning. Dry the corrosion-affected area.
3. Apply a layer of padding epoxy film.

8.5.3. Maintenance

Maintenance procedures should be performed acc. to section 3.8 of the Maintenance Manual.

Section 9
Supplements

(No known supplements 4/6/03)

Intentionally left blank

27-Sep-03